

ExeLED 1

LED-Light Fitting for Ex-Zones 1/21

Series e865...

Applications:

Hazardous locations of zones 1/2 (gas) and 21/22 (dust).

Design:

Housing: Glass fibre reinforced polyester resin.

Cover: Injected polycarbonate, frosted (F) or clear, silicone gasket.

Closure: Stainless steel clips (KE), two of them as safety clip (KES), to be opened with screwdriver only.

Reflector: Sheet Steel, painted, carrying the encapsulated LED-modules, clipped into the cover, removable as a unit.

Connection: 3 poles up to 4 mm².

Cable entries: 3 entries M25 x 1,5, (2 glands - one of them is plugged)

Standard: Facing downwards or forwards.

Mechanical installation:

Mounting accessories see spare parts/ accessories.

Technical Data:

LED: Line modules appr. 6,500K, CRI > 80, lifetime L₈₀ > 100.000h, L₉₀ > 85.000h (06L..), L₉₀ > 80.000h (12L..) at 25°C ambient temperature, lifetime L₈₀ > 100.000h at max. ambient temperature

ECG: 220-240V AC/DC, 0 or 50/60Hz, overvoltage, overload and short circuit protection

Options:

- 4.500K, light colour 845
- for connection to group or central battery (light fittings of version ZB only) or emergency mains respectively
- with monitoring module for monitoring the individual light fitting

- for explosive dust atmospheres Zone 21 (**t868...**)
- for higher ambient temperatures up to +70°C (on demand)
- with through wiring system



Note:

This light fitting is not suitable for application in areas with permanent high humidity in combination with only short periods of operation, such as sewage or stormwater retention tanks or water treatment plants.

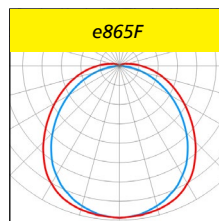
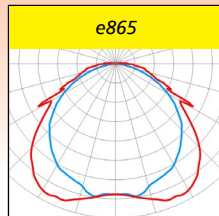

e865 06L..

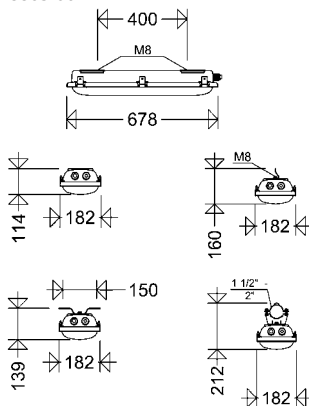

Product highlights:

- innovative encapsulation with high transmission rate
- LED-Modules protected from mechanical or electrostatic damages by sandwich design of reflector and cover
- homogeneous illumination by using frosted diffusers (versions e865F..) no individual light points visible, comfortable perception of light, brilliant glare limitation
- high colour rendering index CRI > 80, according to the workplace guide lines suitable for nearly all plant locations
- **FastFix mounting**, system for variable mounting distances and easy installation (retaining clips HK865 P) without opening the fitting
- ECG and reflector with LED-modules **replacable by qualified personnel on-site**



Looping the cable on one side:

All light fittings of series e865... have got 2 cable entries on one small side of the housing for cable looping instead of the through wiring system.

Article no.	Type	Power consumption [W]	Luminous flux [lm]	Luminous efficacy [lm/W]	Cover frosted	Cover clear	Ta max [°C]	Substitute for *	Weight [kg] (without packing material)

e865...

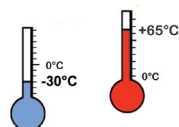
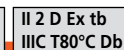
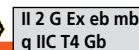

EC-Type Examination Certificate:

IBExU 16 ATEX 1008

Other approvals:

IECEx IBE 16.0010

Ignition protection: eb

Marking:

II 2 G Ex eb mb q IIC T4 Gb (Zone1)

II 2 D Ex tb IIIC T80°C Db (Zone 21)

Rated voltage: 220-240V AC/DC, 0 or 50/60Hz.

Permissible ambient temperature:

-30°C up to see article table

The values given are for versions with through wiring.

86500 0050	e865F 06L22	15	2.170	145	•	55	2 x 18W	4,6
86500 0051	e865F 06L42	28	4.120	147	•	55	2 x 36W	4,7
86500 0052	e865F 06L60	40	5.700	143	•	50	2 x 58W	4,7

* The given information is for rough orientation only. In each individual case a lighting calculation is necessary.

Properties, limitations and details for controlling LED-light fittings:

See "Technical Supplement"

All data are correct at the time of printing. Actual technical data can be found under www.schuch.de.

Article no.	Type	Power consumption [W]	Luminous flux [lm]	Luminous efficacy [lm/W]	Cover frosted	Cover clear	Ta max [°C]	Substitute for *	Weight [kg] (without packing material)
-------------	------	-----------------------	--------------------	--------------------------	---------------	-------------	-------------	------------------	--

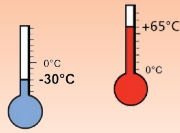

e865...

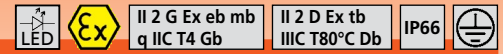

86500 0001	e865F 12L42	28	4.360	156	•		55	2 x 36W	6,7
86500 0002	e865F 12L60	40	6.020	151	•		55	2 x 58W	6,7
86500 0003	e865F 12L85	54	8.620	160	•		50	> 2 x 58W	7,0
86500 0011	e865 12L42	28	4.590	164		•	55	2 x 36W	6,7
86500 0012	e865 12L60	40	6.320	158		•	55	2 x 58W	6,7
86500 0013	e865 12L85	54	9.010	167		•	50	> 2 x 58W	7,0

e865 12L..

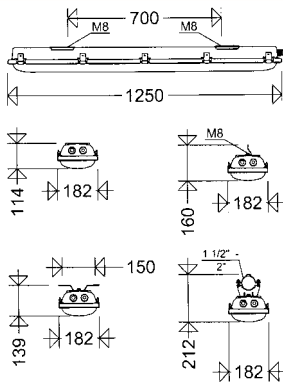

e865... DIMD

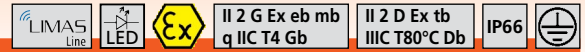

dimmable via DALI interface

Design:
Same as standard version, but with DALI2 compatible ECG and 2 additional clamping points, marked with DA, the polarity does not matter.
Compatible with LIMAS Line Light Management System.

Note:

The conducting wires to the control input must be mains voltage stable and can be integrated in the connection cable.

86500 0952	e865F 06L42 DIMD	28	4.120	147	•		55	2 x 36W	4,7
86500 0953	e865F 06L60 DIMD	40	5.700	143	•		50	2 x 58W	4,7
86500 0914	e865F 12L42 DIMD	28	4.360	156	•		55	2 x 36W	6,7
86500 0906	e865F 12L60 DIMD	40	6.020	151	•		55	2 x 58W	6,7
86500 0903	e865F 12L85 DIMD	54	8.620	160	•		50	> 2 x 58W	7,0

e865... H..



for high temperature ¹⁾

86500 0053	e865F 06L22 H65	15	2.170	145	•		65	2 x 18W	4,6
86500 0054	e865F 06L42 H60	28	4.120	147	•		60	2 x 36W	4,7
86500 0055	e865F 06L60 H55	40	5.700	143	•		55	2 x 58W	4,7
86500 0910	e865F 12L42 H65	28	4.360	156	•		65	2 x 36W	6,7
86500 0902	e865F 12L60 H65	40	6.020	151	•		65	2 x 58W	6,7

* The given information is for rough orientation only. In each individual case a lighting calculation is necessary.

¹⁾ through-wiring or looping the cable is not permissible.

Explosion protected Light Fittings

Accessories / Spare Parts

Article No.	Type	
Spare diffusers		
86601 9001	8654F	PC, frosted for 12L..
86601 9014	8652F	PC, frosted for 06L..
86601 9000	8654	PC, clear for 12L..
Fasteners		
90055 9004	KE/KES VE10	stainless steel, incl. 2 safety clips (packing unit 10 pcs.) see picture on the left, for e 865 12L.. until year of manufacture 2020
90055 9007	KE/KES G2 VE10	stainless steel, incl. 2 safety clips (packing unit 10 pcs.) see picture on the left, for e 865 12L.. from year of manufacture 2020 and for e 865 06L..
Glands/ breather		
90117 9006	2537 G	ex-protected plastic cable gland M25 x 1,5 with nut
90118 9006	2538 G	ex-protected plastic plug M25 x 1,5 with nut
90259 9000	Klimastutzen EX	M25 x 1,5
Mounting material		
86501 9003	HK 865 P	2 retaining clips for variable mounting distances
90001 0002	H8V P	2 suspensions eyes with bolts, stainless steel
90000 0002	15A P	2 ceiling brackets, hot galvanized steel
90032 0002	15AV P	2 ceiling brackets, stainless steel
90037 0004	RO84 112 A P	2 pipe clamps 1 1/2", stainless steel, with support
90038 0004	RO84 2 A P	2 pipe clamps 2", stainless steel, with support
26000 0004	W26 P	2 wall mounting angles
26000 0002	W26/30 P	2 wall mounting angles 30°
26000 0003	W26/45 P	2 wall mounting angles 45°

Fasteners

KE/KES VE10



KE/KES G2 VE10

